

产品/Product: **Internal GPS, CHIP On Board, GPS/BD Passive Antenna Series**

料号/PN: **AHGG.24X7** (Include AHGG.2417, AHGG.2427, AHGG.2437, AHGG.2447)

应用/Application: **GPS / GLONASS, 1575/1602MHz, GNSS Position and Location System**

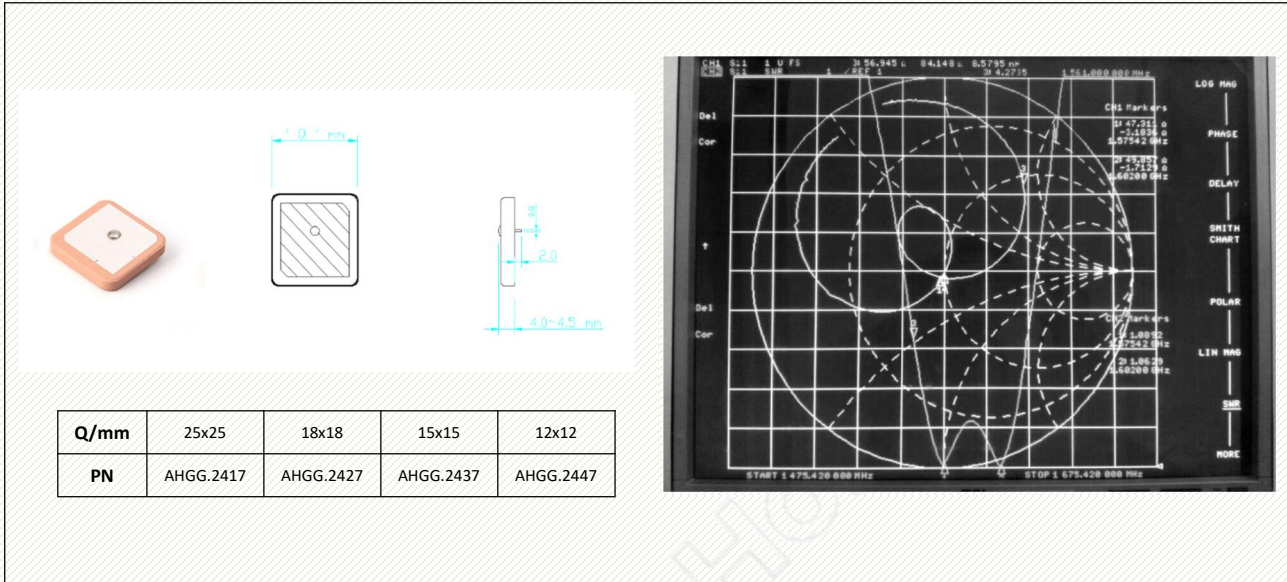





## 电气参数(Electrical Properties)

频率/Frequency:	GPS/1575.42 MHz、GLONASS/1602 MHz
输入阻抗/Impedance:	50 Ω
驻波比/VSWR:	≤2.0
增益/Gain:	3~5 dB
极化方式/Polarization:	RHCP

## 机械参数(Mechanical Properties)

接头&线缆/Conn&Cable:	/
材料&颜色/Material&Color:	Ceramic
安装方式/Mounting:	DIP
尺寸/Size:	Q x Q x 4.0 mm (Q=25,18,15,12)
重量/Weight:	5 g/pcs
工作温度/Operate Temp:	-40 ~ +85 °C

## 关联产品/Relation Product

			
SMA-K DIP ( <a href="#">AHCG.202</a> )	SMA-K ASSY ( <a href="#">AHCG.101</a> )	BOX GPS ( <a href="#">AHGG.132</a> )	Internal Active GPS ( <a href="#">AHGG.232</a> )

## 产品手册/ Product Catalogue

	免费样品申请 Ask free sample
下载地址/Download Link: <a href="http://docs.AntennaHome.com/ant/catalogue.pdf">http://docs.AntennaHome.com/ant/catalogue.pdf</a>	

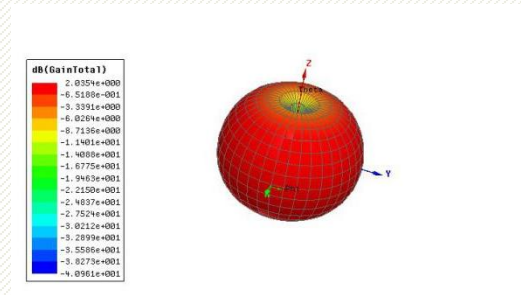
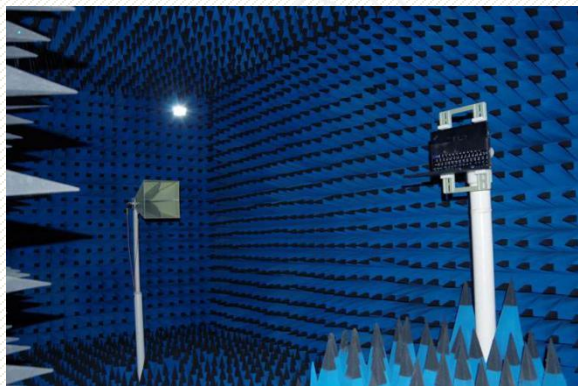

## Online Support

### Contact Us

E-mail : [CS@AntennaHome.com](mailto:CS@AntennaHome.com)

Website : [Http://www.AntennaHome.com](http://www.AntennaHome.com)